

Turmdrehkran 50 EC-B 5

Tower Crane / Grue à tour / Gru a torre
Grúa torre / Guindaste de torre

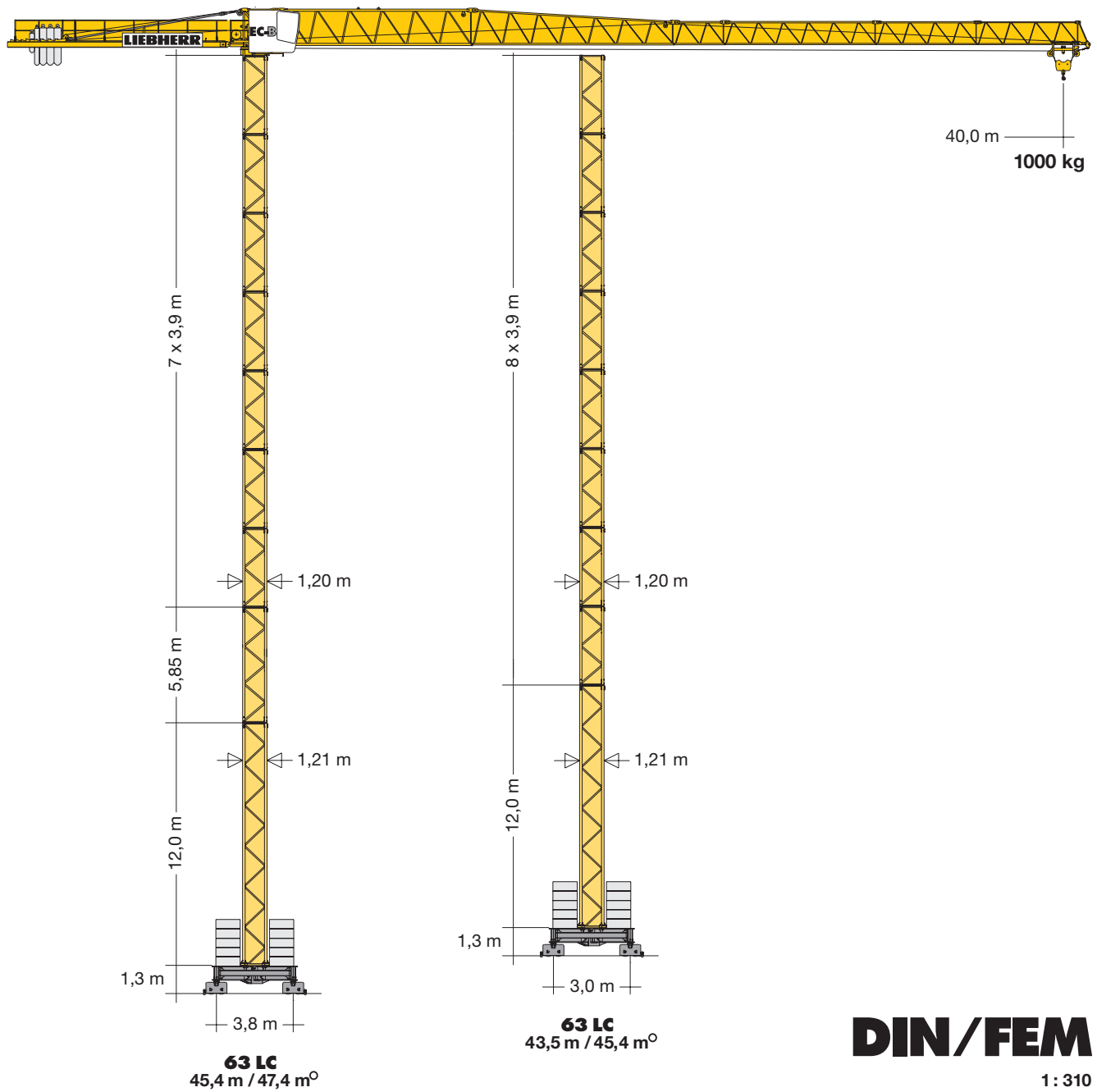

DIN/FEM

1:310

LIEBHERR

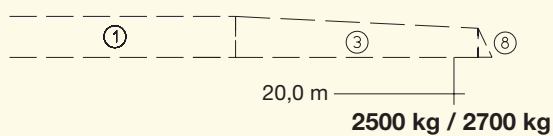
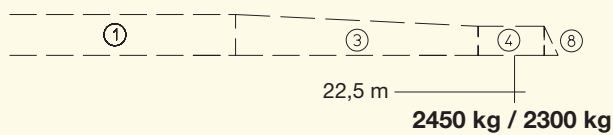
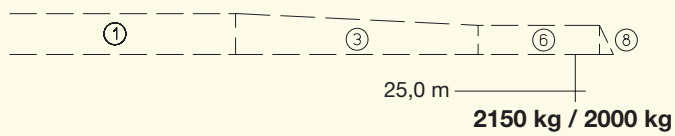
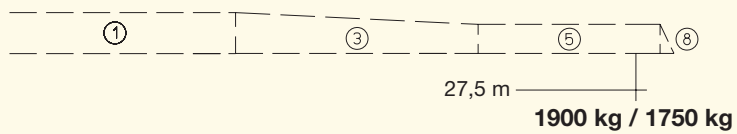
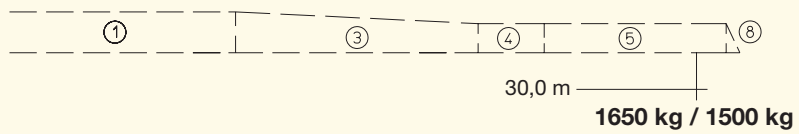
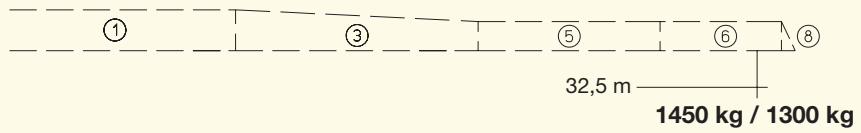
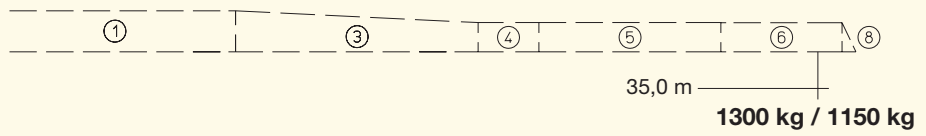
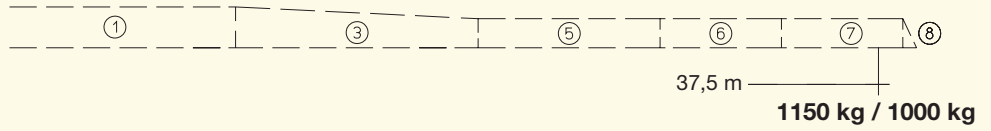
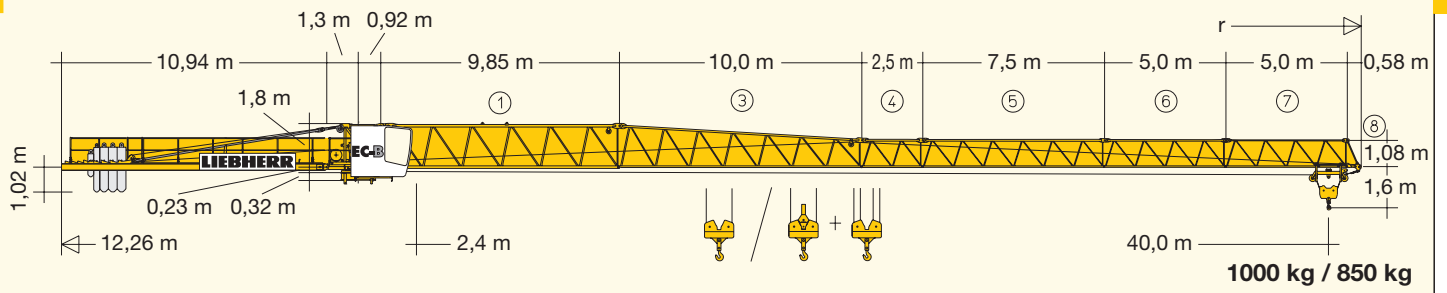

Ausladung und Tragfähigkeit

Radius and capacity / Portée et charge / Sbraccio e portata / Alcances y cargas / Alcance e capacidade de carga

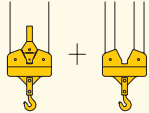
				m/kg													
m	r	m/kg		10,0	12,5	15,0	17,5	20,0	22,5	25,0	27,5	30,0	32,5	35,0	37,5	40,0	
40,0	(r = 41,5)	2,4-19,0	2500	2500	2500	2500	2500	2350	2050	1810	1620	1450	1310	1190	1090	1000	
37,5	(r = 39,0)	2,4-19,8	2500	2500	2500	2500	2500	2470	2150	1900	1700	1530	1380	1260	1150		
35,0	(r = 36,5)	2,4-20,3	2500	2500	2500	2500	2500	2500	2220	1960	1750	1580	1430	1300			
32,5	(r = 34,0)	2,4-20,6	2500	2500	2500	2500	2500	2500	2250	1990	1780	1600	1450				
30,0	(r = 31,5)	2,4-21,1	2500	2500	2500	2500	2500	2500	2320	2050	1830	1650					
27,5	(r = 29,0)	2,4-21,7	2500	2500	2500	2500	2500	2500	2400	2130	1900						
25,0	(r = 26,5)	2,4-21,9	2500	2500	2500	2500	2500	2500	2430	2150							
22,5	(r = 24,0)	2,4-22,1	2500	2500	2500	2500	2500	2500	2450								
20,0	(r = 21,5)	2,4-20,0	2500	2500	2500	2500	2500	2500									
				m/kg													
m	r	m/kg		10,0	12,5	15,0	17,5	20,0	22,5	25,0	27,5	30,0	32,5	35,0	37,5	40,0	
40,0	(r = 41,5)	2,4-18,4	2500	2,4-10,3	5000	3990	3210	2660	2250	1940	1690	1480	1310	1170	1050	940	850
37,5	(r = 39,0)	2,4-19,1	2500	2,4-10,7	5000	4160	3360	2790	2360	2040	1770	1560	1390	1240	1110	1000	
35,0	(r = 36,5)	2,4-19,6	2500	2,4-10,9	5000	4280	3450	2870	2430	2100	1830	1610	1430	1280	1150		
32,5	(r = 34,0)	2,4-19,8	2500	2,4-11,0	5000	4330	3490	2900	2470	2130	1860	1640	1450	1300			
30,0	(r = 31,5)	2,4-20,2	2500	2,4-11,3	5000	4440	3590	2980	2540	2190	1910	1690	1500				
27,5	(r = 29,0)	2,4-20,8	2500	2,4-11,6	5000	4590	3710	3080	2620	2270	1980	1750					
25,0	(r = 26,5)	2,4-20,9	2500	2,4-11,7	5000	4620	3740	3110	2650	2290	2000						
22,5	(r = 24,0)	2,4-21,0	2500	2,4-11,7	5000	4650	3760	3130	2660	2300							
20,0	(r = 21,5)	2,4-20,0	2500	2,4-11,9	5000	4710	3810	3170	2700								

Hubhöhe

Hoisting height / Hauteur sous crochet / Altezza di sollevamento / Altura bajo gancho / Altura de montagem

				63 LC											
3,9 m	3,9 m + 5,85 m	5,85 m	11,7 m												
10	8+1			39,7 ^o	-	-	39,9 ^o	-	40,0 ^o	-	39,3 ^o	-	38,1 ^o	-	
9	7+1	6	3	37,7	-	-	37,9	-	38,0	-	37,3	-	36,2	-	
8	6+1	5		35,8	45,4 ^o	47,4 ^o	36,0	47,6 ^o	36,1	47,7 ^o	35,4	47,0 ^o	34,2	46,1 ^o	
7	5+1	4	2	33,8	43,5	45,4	34,0	45,6	34,1	45,7	33,4	45,0	32,3	44,2	
6	4+1	3		31,9	41,5	43,5	32,1	43,7	32,2	43,8	31,5	43,1	30,3	42,2	
5	3+1	2	1	29,9	39,6	41,5	30,1	41,7	30,2	41,8	29,5	41,1	28,4	40,3	
4	2+1	1		28,0	37,6	39,6	28,2	39,8	28,3	39,9	27,6	39,2	26,4	38,3	
3	1+1			26,0	35,7	37,6	26,2	37,8	26,3	37,9	25,6	37,2	24,5	36,4	
2	0+1			24,1	33,7	35,7	24,3	35,9	24,4	36,0	23,7	35,3	22,5	34,4	
1	0			22,1	31,8	33,7	22,3	33,9	22,4	34,0	21,7	33,3	20,6	32,5	
0				20,2	29,8	31,8	20,4	32,0	20,5	32,1	19,8	31,4	18,6	30,5	
				18,2	27,9	29,8	18,4	30,0	18,5	30,1	17,8	29,4	16,7	28,6	
				16,3	25,9	27,9	16,5	28,1	16,6	28,2	15,9	27,5	14,7	26,6	
				14,3	24,0	25,9	14,5	26,4	14,6	26,5	13,9	25,8	12,8	24,7	
				12,4	22,1	24,0	12,6	24,2	12,7	24,3	12,0	23,6	10,8	22,7	
				10,4	20,1	22,0	10,6	22,2	10,7	22,3	10,0	21,6	8,9	20,8	
				8,5	18,1	20,1	8,7	20,3	8,8	20,4	8,1	19,7	6,9	18,9	
				6,5	16,2	18,1	6,8	18,3	6,9	18,4	6,2	17,7	5,0	16,9	
				4,6	12,3	16,2	4,8	16,5	4,9	16,6	4,2	15,9	3,0	14,9	
				-	12,3	12,3	-	12,5	-	12,6	-	11,9	-	11,0	

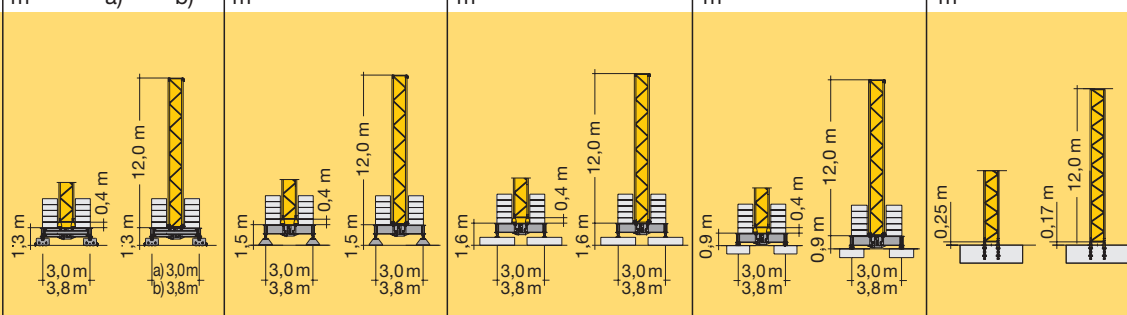

o = Ohne Kabine / Without cabin / Sans cabine / Senza cabina / Sin cabina / Sem cabine













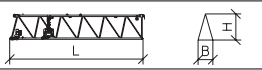

Weitere Hubhöhen sowie Klettern auf Anfrage. / Further hoist heights and climbing on request. / Hauteurs sous crochet plus élevées et hissage sur demande. / Altre altezze di sollevamento come pure telescopaggio, su richiesta. / Para alturas bajo gancho superiores y trepado, consultar. / Outras alturas de elevação e ascensionamento, mediante consulta.

Antriebe

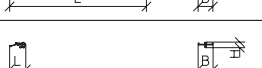
Driving units / Mécanismes d'entraînement / Azionamenti / Mecanismos / Mecanismos

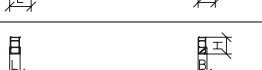
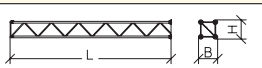
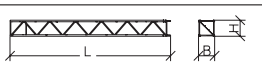
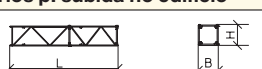
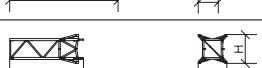
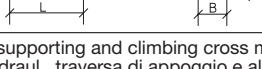
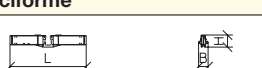
	U/min 0 ↔ 0,8 sl./min tr./min	5,0 kW EDC
	0 ↔ 60,0 m/min 0 ↔ 63,0 m/min	1,5 kW FU 3,0 kW FU
	25,0 m/min 25,0 m/min	2 x 3,0 kW FU 2 x 4,0 kW
	kVA	14,0 kW 29,0

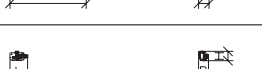
	Stufe / Step Cran / Marcia Marcha / Marcha	kg	m/min
 3,2/14,0/14,0 kW WIW210 MZ402 4 Lagen Layers Couches Strati Camadas Capas 57,0 m/28,0 m LS-Trommel	1	2500	2500 6,2
	2	2500	2500 27,0
	3	1300	1200 54,0
 6 Lagen Layers Couches Strati Camadas Capas 90,0 m/45,0 m LS-Trommel	1	5000	3,1
	2	5000	13,5
	3	2500	27,0
 14,0 kW 29,0	1	4700	3,3
	2	4700	14,3
	3	2350	28,5

Kranoberteil		Upper part of crane / Partie supérieure de grue / Parte superiore della gru		L (m)	B (m)	H (m)	kg*	
Pos. Item Ref.	Anz. Qty. Cant.							
1	1	Drehbühne kpl. / Slewing platform cpl. Ensemble mât cabine cpl. / Piattaforma girevole compl. / Plataforma giratória compl. Conjunto plataforma de giro		2,43	2,74	2,52	3520	
2	1	Drehbühne / Slewing platform Ensemble mât cabine / Piattaforma girevole / Plataforma giratória compl. Conjunto plataforma de giro		2,43	1,99	2,52	3310	
3	1	Podeste / Platforms Plates-formes / Pedana Plataformas / Plataformas		2,07 2,07 2,13	0,59 1,04 0,60	1,31 1,31 1,33	100 110 120	
4	1	Kabine / Cabin Cabine / Cabina Cabina / Cabina		1,35	2,38	2,28	580	
5	1	Gegenausleger / Counter-jib Contre-flèche / Contrabaccio Contrapluma / Contra-lança		11,02	1,39	0,66	2190	
6	1	Podeste Gegenausleger / Counter-jib platforms Plates-formes de contre-flèche / Ballatoi controfreccia Plataforma contrapluma / Plataforma contra-lança		3,00	0,75	1,32	140	
7	1	Ausleger-Anlenkstück / Jib heel section Pied de flèche / Settore articolato di braccio Pluma tramo primero / Base articulada de lança		10,05	1,23	1,95	① 1820	
8	1	Ausleger-Zwischenstück / Intermediate jib section Élément intermédiaire de flèche / Spezzone di braccio Tramo intermedio pluma / Peça suplementar da lança		2,69 7,68 5,17 5,17	1,10 1,10 1,10 1,10	1,25 1,24 1,23 1,23	④ 160 ⑤ 380 ⑥ 200 ⑦ 170	
9	1	Ausleger-Zwischenstück / Intermediate jib section Élément intermédiaire de flèche / Spezzone di braccio Tramo intermedio pluma / Peça suplementar da lança		10,20	1,10	1,83	③ 740	
10	1	Ausleger-Kopfstück / Jib head section Pointe de flèche / Punta freccia Tramo punta de pluma / Cabeça de lança		1,24	1,11	0,44	⑧ 60	
11	1	Laufkatze / Trolley Chariot / Carrello Carrito / Carrinho		1,60	1,28	0,78	163	
12	1	Fahrkorb / Maintenance cage Nacelle d'entretien / Cestello di manutenzione Plataforma de mantenimiento		0,78	0,66	1,25	35	
Turm		Tower / Mât / Torre						
13	1	Grundturmstück / Base tower section Mât de base / Elemento di torre base Tramo torre base / Peça de base de torre		12,00	1,42	1,42	3320	
14	1	Turmstück / Tower section Élément de mât / Elemento di torre Tramo torre / Torre		3,90 m 5,85 m 11,70 m	4,17 6,12 11,97	1,20 1,20 1,20	970 1330 2450	
Klettereinrichtung		Climbing equipment / Equipement de télescopage / Attrezzatura per allungamento della gru						
15	1	Führungsstück kpl. / Guide section cpl. Cage télescopique cpl. / Gabbia di sopraelevazione compl. Torre de montaje completa / Peça de guia compl.		8,74	1,66	1,75	2680	
16	1	Führungsstück Turmstück / Tower guide section Élément de mât télescopique / Gabbia de sopraelevazione Tramo torre de montaje / Peça de guia		3,90 m	4,17	1,66	1190	
17	1	Hydraulikanlage, Stütz- und Klettertraverse / Hydraulic unit, supporting and climbing cross members Système hydraul. avec traverses d'appui et de télescop. / Sist. idraul., traversa di appoggio e allugam. gru Sistema hidráulico con traviesa de apoyo y trepado / Instalação hidráulica, travessa de apoio e subida		2,00	0,90	0,80	530	
Fundamentkreuz		Cruciform base / Châssis en croix / Carro della gru						
18	1	Tragholm I / Arm I Longeron I / Longherone I Brazo I / Travessa I		3,0 m 3,8 m	4,88 5,68	0,71 0,71	0,81 0,81	1550 1790
19	1	Tragholm II / Arm II Longeron II / Longherone II Brazo II / Travessa II		3,0 m 3,8 m	4,88 5,68	0,78 0,78	0,66 0,66	1340 1580
20	2	Fahrschemel mit Antrieb / Rail bogie with drive Bogie moteur / Telajo con gruppia propulsore Caja rodillo motriz / Quadra sem grupa de propulsão		1,31 0,96	0,66 0,38	0,61 0,42	630 280	
21	2	Fahrschemel ohne Antrieb / Rail bogie without drive Bogie fou / Telajo senza gruppia propulsore Caja rodillo conducido / Quadra com grupa de propulsão		1,04 0,38	0,33 0,31	0,61 0,42	330 200	

* Einzelgewichte. / Single weights. / Poids individuels. / Pesì di componenti. / Pesos unitarios. / Pesos de peças componentes.

Konstruktionsänderungen vorbehalten!

Subject to alterations! / Sous réserves de modifications!
Si fa riserva di modifiche! / ¡Sujeto a modificaciones!
Salvo modificação da construação!

Sämtliche Angaben erfolgen ohne Gewähr. / This information is supplied without liability.

Ces renseignements sont sans garantie. / Le indicazioni contenute si intendono salvo errori ed omissioni.
Declinamos toda responsabilidad derivada de la información proporcionada. / Declinamos qualquer
responsabilidade quanto à informação fornecida.

120 P – 5139 H1 B3 DIN 15018 • BGL C.0.10.0045 / FEM (Section 1) – Krangruppe A3 • 04.07 / 6

Printed in Germany.

Liebherr-Werk Biberach GmbH
Postfach 1663, D-88396 Biberach an der Riss
☎ +49 73 51 41-0, Fax: +49 73 51 41 22 25
www.liebherr.com, E-Mail: info.lbc@liebherr.com

Liebherr Industrias Metálicas, S.A.
Polígono Industrial Agustinos, Apartado 4096, E-31014 Pamplona
☎ +34-948-29 70 00, Fax +34-948-29 70 29
www.liebherr.com, E-Mail: info.lim@liebherr.com